

# ***Kanlux***

Oprawa natynkowa  
Kanlux **STOBI**



**Kanlux**

**Niezawodne  
w każdym  
wnętrzu  
komercyjnym**

**Kanlux**

**Niezastąpione  
w każdym  
wnętrzu  
prywatnym**



# Kanlux

## STOBI DLP

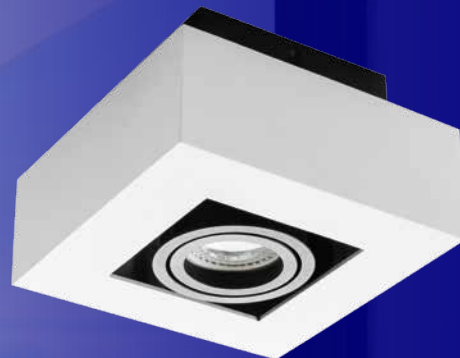

+



PAR16 LED GU10

## STOBI ES



+



ES-111 LED GU10

Brak źródła w komplecie.

# Kanlux

**NEW**

# Kanlux **STOBI ES**



STOBI ES 250-W **26839**



STOBI ES 50-W **26829**



STOBI ES 250-B **26838**



STOBI ES 50-B **26828**

**Jedyna taka**  
oprawa natynkowa  
na ES 111!!!

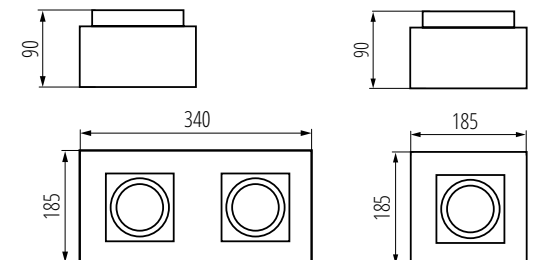



- STOBI DLP 50-B **26830**
- STOBI DLP 50-W **26831**

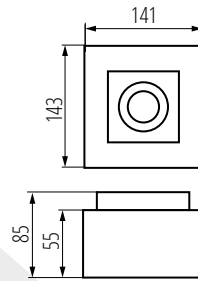

- STOBI DLP 350-B **26834**
- STOBI DLP 350-W **26835**

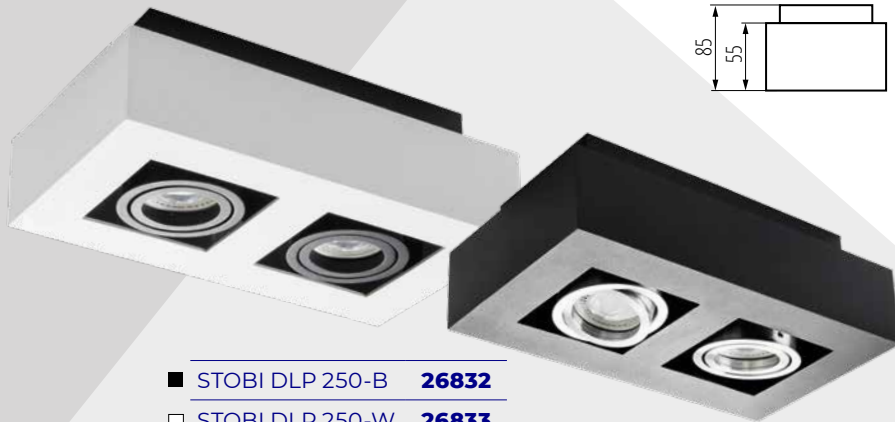
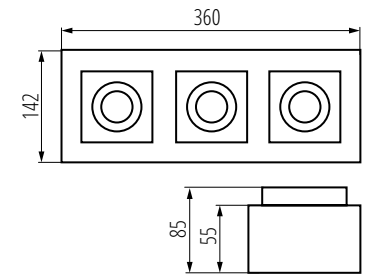

- STOBI DLP 250-B **26832**
- STOBI DLP 250-W **26833**

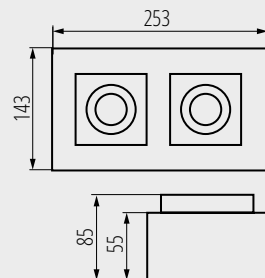

- STOBI DLP 450-B **26836**
- STOBI DLP 450-W **26837**

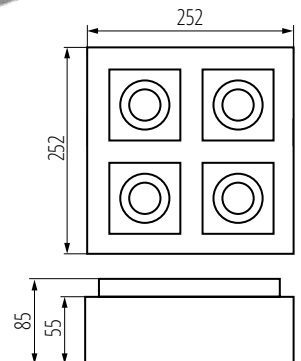

**Kanlux**

**Dwustopniowa**  
regulacja kąta  
pierścienia oprawy  
**STOBI ES** ( $\pm 20^\circ / \pm 20^\circ$ ),  
**STOBI DLP** ( $\pm 65^\circ / \pm 45^\circ$ ).



# Kanlux

## Różnice **STOBI / STOBI ES**

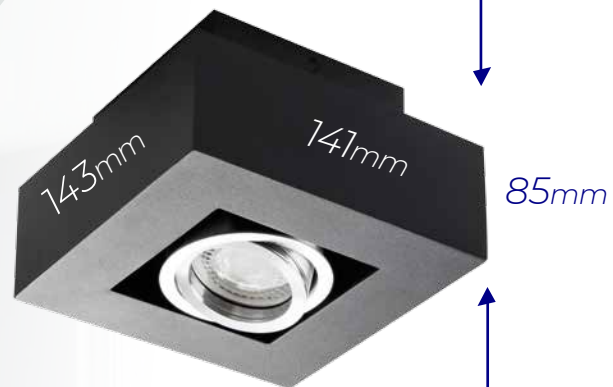

STOBI DLP 50-B **26830**



STOBI ES 50-B **26828**





**Kanlux**

**Wysoka**

jakość wykonania

**Piaskowana, aluminiowa**

obudowa oprawy

w matowej bieli lub czerni.

**Minimalistyczna stylistyka.**

# Kanlux

**NEW**

## Dane ogólne:

- seria opraw na źródło **ES 111**,
- kolory: **biały mat (W)**, **czarny mat (B)**,
- oprawy **1- i 2- punktowe**

## Dane techniczne:

- zasilanie: 220-240V~ AC,
- moc max. 25W / 2x 25W,
- trzonek: **GU10**,
- źródło: **ES 111**,
- regulacja kątowna: w **2 osiach ( $\pm 20^\circ/\pm 20^\circ$ )**
- materiał: aluminium
- szczelność: **IP20**
- klasa ochrony: **I**

**Kanlux STOBI ES 50-W**



**Kanlux STOBI ES 250-W**



## Dane ogólne:

- seria opraw na źródło **PAR16 LED**,
- kolory: **biały mat (W)**, **czarny mat (B)**,
- oprawy **1-, 2-, 3- oraz 4-punktowe**

## Dane techniczne:

- zasilanie: 220-240V~ AC,
- moc max. 25W / 2x 25W / 3x 25W / 4x 25W,
- trzonek: **GU10**,
- źródło: **PAR16 LED**,
- regulacja kątowna: w **2 osiach ( $\pm 65^\circ/\pm 45^\circ$ )**
- materiał: aluminium
- szczelność: **IP20**
- klasa ochrony: **I**

**Kanlux STOBI  
DLP 50-W**

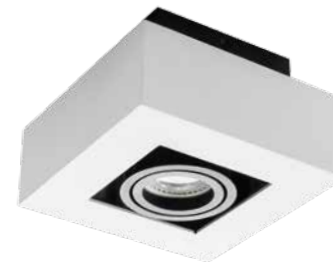

**Kanlux STOBI  
DLP 250-W**



**Kanlux STOBI  
DLP 350-W**



**Kanlux STOBI  
DLP 450-W**



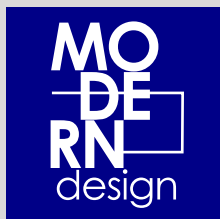
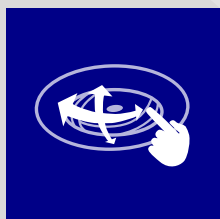

## Zestawienie modeli



PAR16  
LED GU10



ES-111  
LED GU10

<b>max 25W</b>	STOBI DLP 50-B	<b>26830</b>	143x141x85 mm
	STOBI DLP 50-W	<b>26831</b>	
<b>2 x max 25W</b>	STOBI DLP 250-B	<b>26832</b>	253x143x85 mm
	STOBI DLP 250-W	<b>26833</b>	
<b>3 x max 25W</b>	STOBI DLP 350-B	<b>26834</b>	360x142x85 mm
	STOBI DLP 350-W	<b>26835</b>	
<b>4 x max 25W</b>	STOBI DLP 450-B	<b>26836</b>	252x252x85 mm
	STOBI DLP 450-W	<b>26837</b>	
<b>max 25W</b>	STOBI ES 50-B	<b>26828</b>	185x185x90 mm
	STOBI ES 50-W	<b>26829</b>	
<b>2 x max 25W</b>	STOBI ES 250-B	<b>26836</b>	340x185x90mm
	STOBI ES 250-W	<b>26837</b>	

Oprawa sufitowa punktowa, natynkowa

Materiał: aluminium

# Kanlux

**NEW**

Kanlux **STOBI ES**



**Dobrze spakowany**

[kanlux.com](http://kanlux.com)

# Kanlux

## Kanlux **STOBI DLP**



**Dobrze spakowany**

[kanlux.com](http://kanlux.com)